

SLOTTED-HEEL CLAMP STRAPS

INFO+: SEE PAGES 96, 102, 249, 295-300, 302-303, 310, 311-314 FOR MATERIAL SPECIFICATIONS



Steel

A complete clamp-strap assembly using a slotted-heel strap from (INFO+ page 248). Select any of the six nut/knob combinations shown below by adding the appropriate suffix to the part number. Other Stud and Clamp Rest lengths are available (order pieces individually).

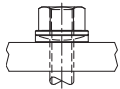

Spherical Nut & Washer
CL-xx-SHA-1

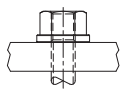

Flange Nut
CL-xx-SHA-2

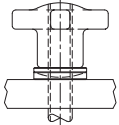

Hand Knob with Spherical Washer
CL-xx-SHA-4

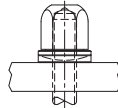

Acorn Nut with Spherical Washer
CL-xx-SHA-5

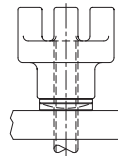

Bar Knob with Spherical Washer*
CL-xx-SHA-6

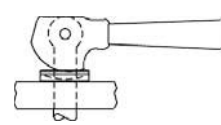

Cam Handle with Spherical Washer

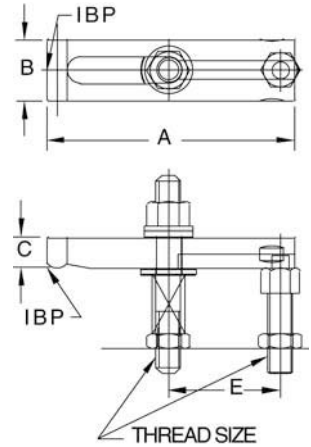

ASSEMBLIES — STEEL (INCH)

PART NO.	THREAD SIZE	A	B	C	E	CLAMP STRAP	CLAMP REST	SPRING	FLAT WASHER	STUD
CL-0-SHA-x	1/4-20	2	5/8	3/8	27/32	CL-0-CS	CL-1-CR	CL-5-SPG	CL-7-FW	CL-1/4-20x2.50-STUD
CL-1-SHA-x		2-1/2			1-3/32	CL-1-CS				
CL-1A-SHA-x	5/16-18	2-1/2	3/4	1/2	1-1/4	CL-1A-CS	CL-1A-CR	CL-6-SPG	CL-14-FW	CL-5/16-18x3.00-STUD
CL-1B-SHA-x		3			1-11/32	CL-1B-CS				
CL-2-SHA-x	3/8-16	3	1-1/8	1/2	1-9/32	CL-2-CS	CL-2-CR	CL-7-SPG	CL-1-FW	CL-3/8-16x3.00-STUD
CL-3-SHA-x		3-1/2			1-17/32	CL-3A-CS				
CL-4-SHA-x		4			1-25/32	CL-3-CS				
CL-6-SHA-x		5			2-9/32	CL-4-CS				
CL-8-SHA-x		6			2-25/32	CL-5-CS				
CL-9-SHA-x		3-1/2			1-1/2	CL-6A-CS				
CL-10-SHA-x	1/2-13	4	1-1/4	5/8	1-3/4	CL-6-CS	CL-4-CR	CL-9-SPG	CL-2-FW	CL-1/2-13x4.00-STUD
CL-12-SHA-x		5			2-1/4	CL-8-CS				
CL-14-SHA-x		6			2-3/4	CL-10-CS				
CL-20-SHA-x		4			1-11/16	CL-15A-CS				
CL-22-SHA-x	5/8-11	5	1-1/2	7/8	2-3/16	CL-16-CS	CL-6-CR	CL-11-SPG	CL-3-FW	CL-5/8-11x4.50-STUD
CL-24-SHA-x		6			2-11/16	CL-18-CS				
CL-25-SHA-x		6-1/2			2-15/16	CL-18A-CS				
CL-27-SHA-x	3/4-10	6	1-3/4	1	2-5/8	CL-19-CS	CL-8-CR	CL-13-SPG	CL-4-FW	CL-3/4-10x5.00-STUD
CL-29-SHA-x		7			3-1/8	CL-21-CS				
CL-31-SHA-x		8			3-5/8	CL-22A-CS				

ASSEMBLIES — STEEL (METRIC)

PART NO.	THREAD SIZE	THREAD PITCH (mm)	A (mm)	B (mm)	C (mm)	E (mm)	CLAMP STRAP	CLAMP REST	CLAMP SPRING	FLAT WASHER	CLAMPING STUD	JAM NUT
CLM-0-SHA-x	M6	1	51	16	9.5	21.5	CL-0-CS	CLM-1-CR	CL-5-SPG	CL-7-FW	CLM-6 x 65-STUD	CLM-6-JN
CLM-1-SHA-x			63.5			28	CL-1-CS					
CLM-1A-SHA-x	M8	1.25	76	19	12.5	32	CL-1A-CS	CLM-1A-CR	CL-6-SPG	CL-14-FW	CLM-8 x 80-STUD	CLM-8-JN
CLM-1B-SHA-x						34	CL-1B-CS					
CLM-2-SHA-x	M10	1.5	89	28.5	12.5	32.5	CL-2-CS	CLM-2-CR	CL-7-SPG	CL-1-FW	CLM-10 x 80-STUD	CLM-10-JN
CLM-3-SHA-x			39			CL-3A-CS						
CLM-4-SHA-x			45			CL-3-CS						
CLM-6-SHA-x			58			CL-4-CS						
CLM-8-SHA-x			70.5			CL-5-CS						
CLM-9-SHA-x			38			CL-6A-CS						
CLM-10-SHA-x	M12	1.75	101.5	32	16	44.5	CL-6-CS	CLM-4-CR	CL-9-SPG	CL-2-FW	CLM-12 x 95-STUD	CLM-12-JN
CLM-12-SHA-x			57			CL-8-CS						
CLM-14-SHA-x			70			CL-10-CS						
CLM-20-SHA-x			43			CL-15A-CS						
CLM-22-SHA-x	M16	2	127	38	22	55.5	CL-16-CS	CLM-5-CR	CL-11-SPG	CL-3-FW	CLM-16 x 110-STUD	CLM-16-JN
CLM-24-SHA-x			68.5			CL-18-CS						
CLM-25-SHA-x			75			CL-18A-CS						
CLM-27-SHA-x	M20	2.5	152	44.5	25.5	66.5	CL-19-CS	CLM-8-CR	CL-13-SPG	CL-4-FW	CLM-20 x 125-STUD	CLM-20-JN
CLM-29-SHA-x			79.5			CL-21-CS						
CLM-31-SHA-x			92			CL-22A-CS						
			CLM-10-FW									