

HAND-RETRACTABLE PLUNGERS

STEEL: 1215 BODY, 1215 PLUNGER CASE HARDENED (OR DELRIN®, 17-7PH SPRING).
ALL STEEL COMPONENTS ZINC PLATED CLEAR CHROMATE.

STAINLESS STEEL: 300 SERIES

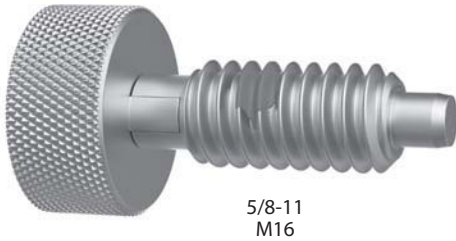

5/8-11
M16

Spring-loaded plunger that locks in retracted position. To lock, pull knurled knob back and turn 90°. Standard plunger has a slight taper on plunger tip for easy alignment. Also available with a radiused Delrin® plunger (slightly larger diameter and lighter spring force). Available in steel or stainless steel.

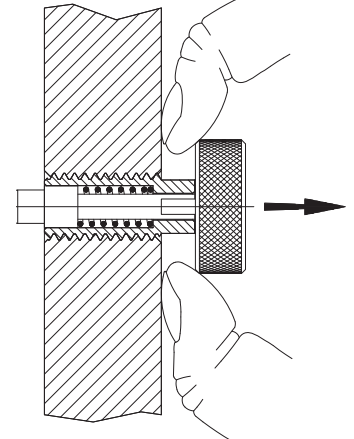

Pull knob to retract...

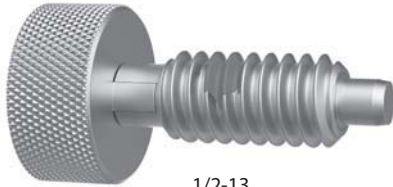

1/2-13
M12

Knurled Head (Locking Type)

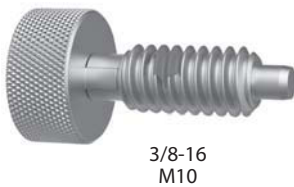

3/8-16
M10

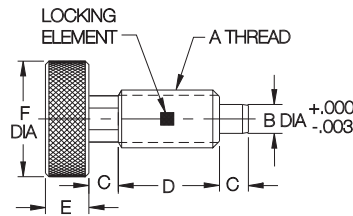

Standard Plunger

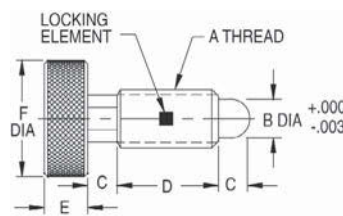

Radiused Delrin® Plunger

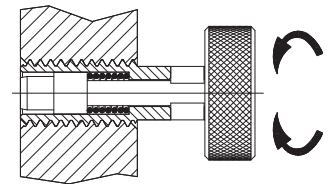

...then turn 90° in either direction to lock.



5/16-18
M8

KNURLED HEAD — STEEL (INCH)



1/4-20
M6



#10-32

PART NO. STANDARD PLUNGER	PART NO. RADIUSED DELRIN PLUNGER	A	STANDARD PLUNGER				RADIUSED DELRIN® PLUNGER				C	D	E	F DIA
			END FORCE (LBS)		B DIA		END FORCE (LBS)		B DIA					
			INITIAL	FINAL	NOMINAL	ACTUAL	INITIAL	FINAL	NOMINAL	ACTUAL				
CL-3-HRP	—	#10-32	1	3.5	7/64	.105	—	—	—	—	3/32	13/32	3/16	3/8
CL-4-HRP	CL-4-HRPN	1/4-20	1	5	1/8	.125	.5	2.5	5/32	.145	1/8	1/2	1/4	1/2
CL-5-HRP	CL-5-HRPN	5/16-18	1.5	6	5/32	.156	.7	3	3/16	.180	3/16	5/8	9/32	5/8
CL-6-HRP	CL-6-HRPN	3/8-16	1.5	8	3/16	.187	.7	4	7/32	.217	7/32	3/4	5/16	3/4
CL-8-HRP	CL-8-HRPN	1/2-13	2.5	10	1/4	.250	1.2	5	5/16	.311	1/4	7/8	3/8	1
CL-10-HRP	CL-10-HRPN	5/8-11	5	10	5/16	.312	3	6	3/8	.374	5/16	1	3/8	1-1/8

KNURLED HEAD — STAINLESS (INCH)

PART NO. STANDARD PLUNGER	PART NO. RADIUSED DELRIN PLUNGER	A	STANDARD PLUNGER				RADIUSED DELRIN® PLUNGER				C	D	E	F DIA
			END FORCE (LBS)		B DIA		END FORCE (LBS)		B DIA					
			INITIAL	FINAL	NOMINAL	ACTUAL	INITIAL	FINAL	NOMINAL	ACTUAL				
CL-3-HRP-S	—	#10-32	1	3.5	7/64	.105	—	—	—	—	3/32	13/32	3/16	3/8
CL-4-HRP-S	CL-4-HRPN-S	1/4-20	1	5	1/8	.125	.5	2.5	5/32	.145	1/8	1/2	1/4	1/2
CL-5-HRP-S	CL-5-HRPN-S	5/16-18	1.5	6	5/32	.156	.7	3	3/16	.180	3/16	5/8	9/32	5/8
CL-6-HRP-S	CL-6-HRPN-S	3/8-16	1.5	8	3/16	.187	.7	4	7/32	.217	7/32	3/4	5/16	3/4
CL-8-HRP-S	CL-8-HRPN-S	1/2-13	2.5	10	1/4	.250	1.2	5	5/16	.311	1/4	7/8	3/8	1
CL-10-HRP-S	CL-10-HRPN-S	5/8-11	5	10	5/16	.312	3	6	3/8	.374	5/16	1	3/8	1-1/8

KNURLED HEAD — STEEL (METRIC)

PART NO. STANDARD PLUNGER	PART NO. RADIUSED DELRIN PLUNGER	A THREAD	THREAD PITCH (mm)	INITIAL END FORCE (N)	FINAL END FORCE (N)	B DIA (mm)	C (mm)	D (mm)	E (mm)	F DIA (mm)
CLM-6-HRP	—	M6	1	4	22	3	3.2	12.5	6.5	12.5
CLM-8-HRP	—	M8	1.25	7	27	4	4.8	16	7	16
CLM-10-HRP	—	M10	1.5	7	36	5	5.5	19	8	19
CLM-12-HRP	—	M12	1.75	11	44	6	6.5	22	9.5	25.5
CLM-16-HRP	—	M16	2	22	44	8	8	25.5	9.5	28.5

KNURLED HEAD — STAINLESS (METRIC)

CLM-6-HRP-S	—	M6	1	4	22	3	3.2	12.5	6.5	12.5
CLM-8-HRP-S	—	M8	1.25	7	27	4	4.8	16	7	16
CLM-10-HRP-S	—	M10	1.5	7	36	5	5.5	19	8	19
CLM-12-HRP-S	—	M12	1.75	11	44	6	6.5	22	9.5	25.5
CLM-16-HRP-S	—	M16	2	22	44	8	8	25.5	9.5	28.5

